

MONTAGEANLEITUNG

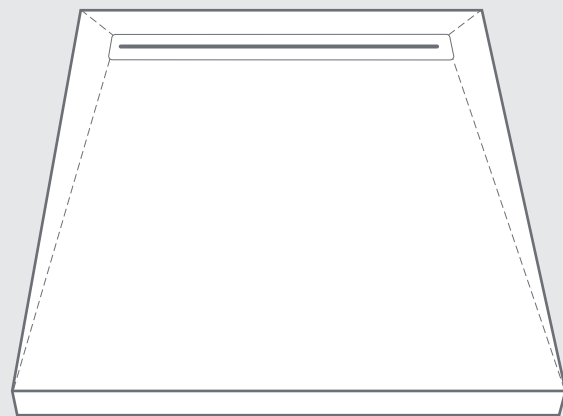

Duschelement aus Mineralwerkstoff mit Slimline & Ultra-Slimline Rinnenablauf



einseitiges Gefälle



vierseitiges Gefälle

Werkzeuge:	Montagezubehör: * optional bestellbar
 Zollstock	 Dichtinnen- und Außenecken
 Tacker	 Verbundkleber
 Bleistift	 Randdämmstreifen
 Cuttermesser	 Dichtset für Wand und Boden
 Wasserwaage	 Sand-Zement Mischung (alternativ SAXOBOARD-Unterbauelement)
 Zahnkelle 8mm	
 Wasserbehälter	

Gern beantworten wir Ihre Fragen unter: **03522 / 52 84 90**
(Mo bis Fr 8 - 20 Uhr / Sa, So, Feiertage 10 - 20 Uhr)

oder erfahren Sie mehr im Montagevideo unter:
www.saxoboard.net/details-montage/video.html

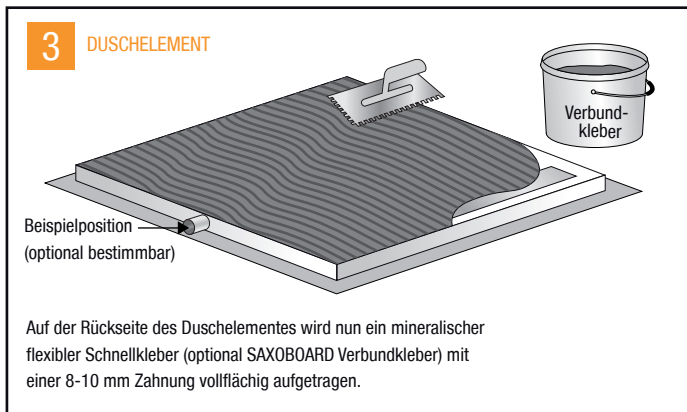
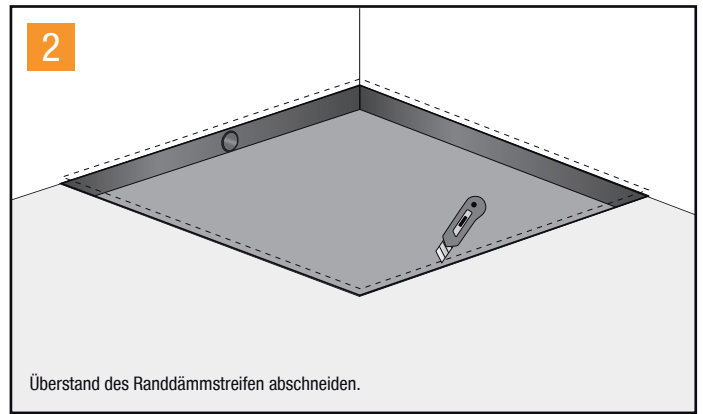
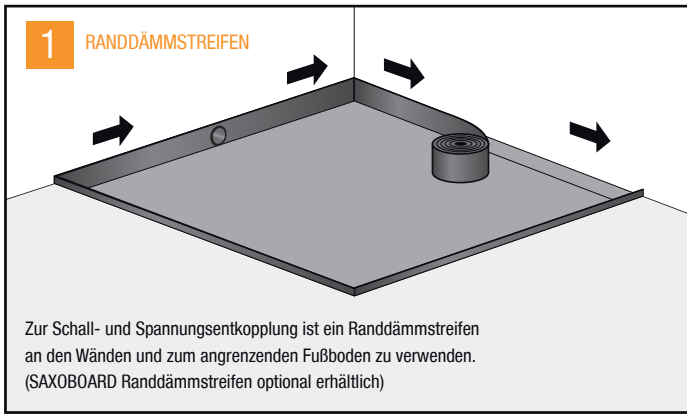

Einbau waagerechter Ablauf:

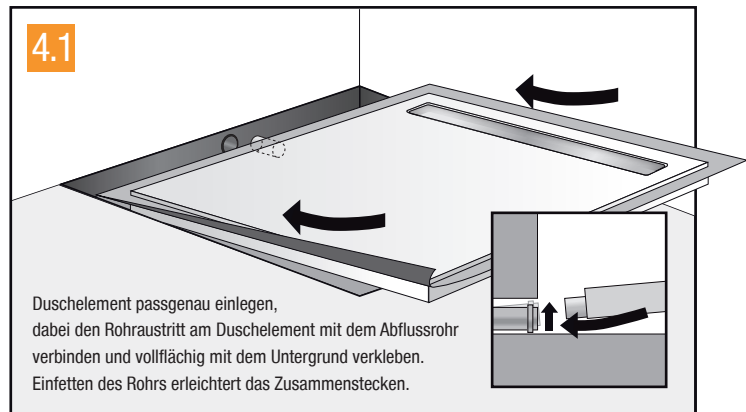

Einbau senkrechter Ablauf:

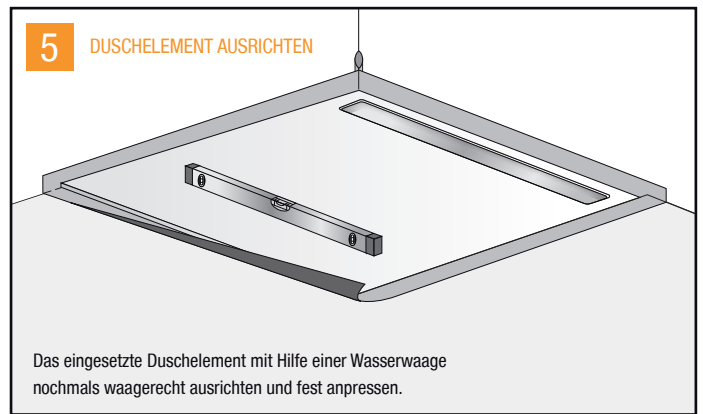
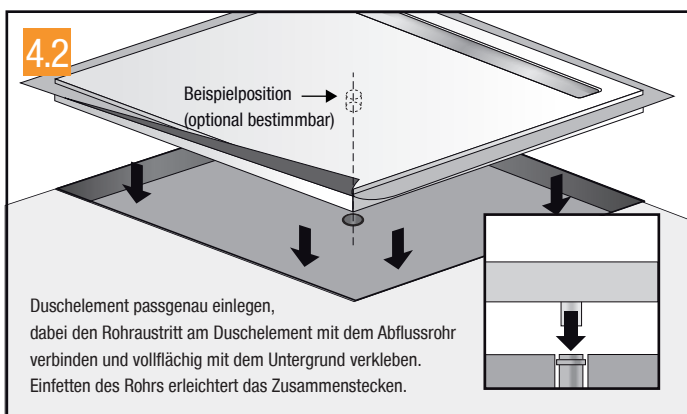

Gefälleprofil Aquakeil* (optional erhältlich)

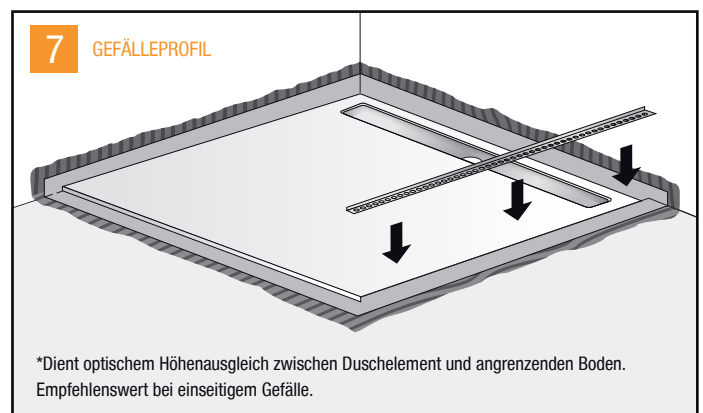
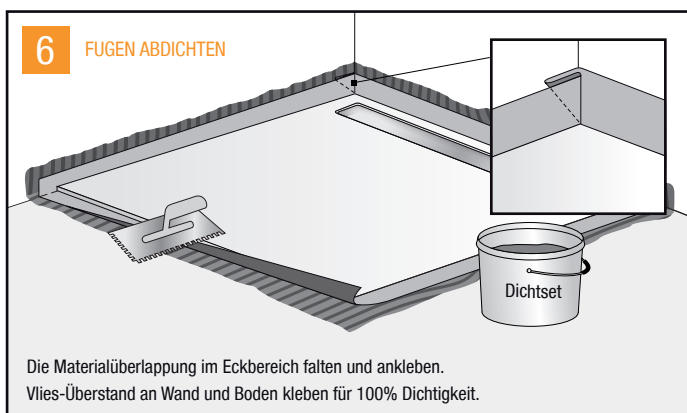

Gefälleprofil mit Glasaufnahme* (optional erhältlich)

