

MONTAGEANLEITUNG

Duschelement Slimline & Ultra-Slimline mit Rinnenablauf

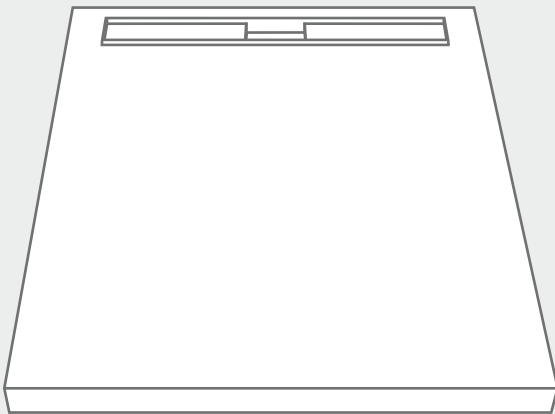

einseitiges Gefälle

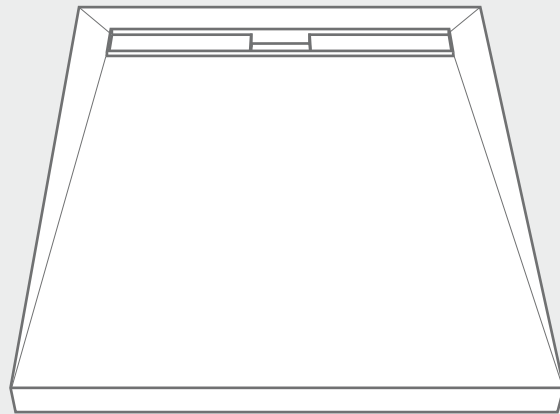

vierseitiges Gefälle

Werkzeuge:	Montagezubehör: * optional bestellbar
 Zollstock	 Dichtinnen- und Außenecken ②
 Tacker	 Verbundkleber
 Bleistift	 Randdämmstreifen
 Cuttermesser	 Dichtset für Duschelemente ①
 Wasserwaage	 Sand-Zement Mischung (alternativ SAXOBOARD-Unterbaulement)
 Zahnkelle 8mm	 Duschboardecke ③
 Wasserbehälter	

Gern beantworten wir Ihre Fragen unter: **03522 / 52 84 90**
(Mo bis Fr 8 - 20 Uhr / Sa, So, Feiertage 10 - 20 Uhr)

oder erfahren Sie mehr im Montagevideo unter:
www.saxoboard.net/details-montage/video.html

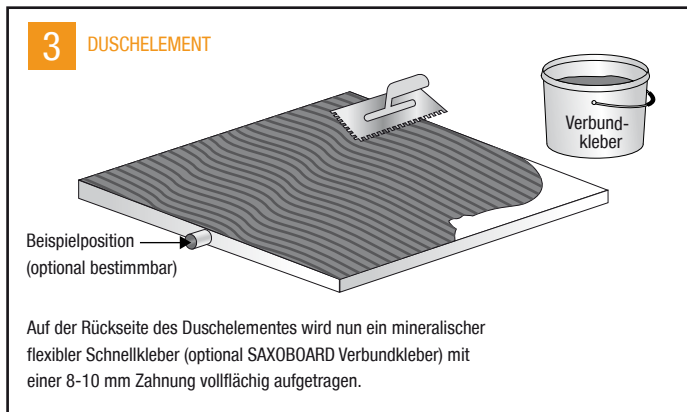
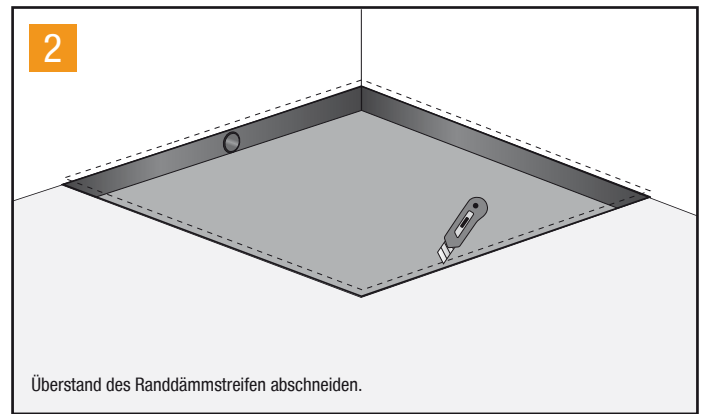
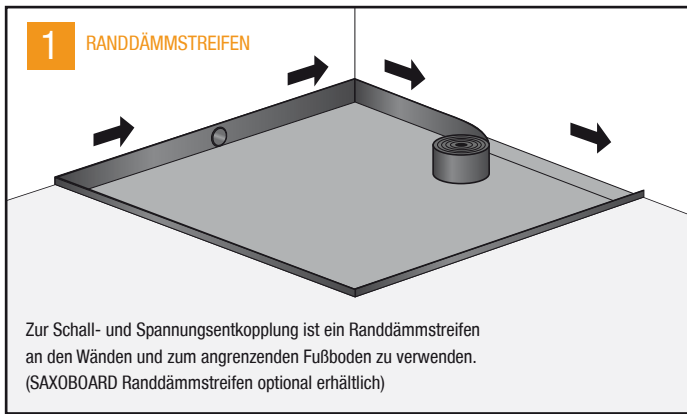

Einbau waagerechter Ablauf:

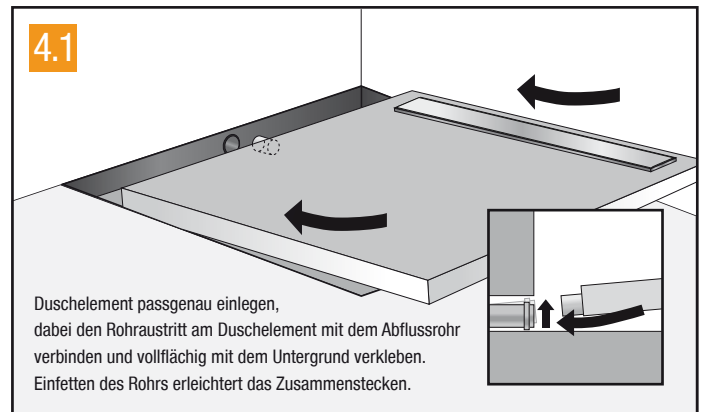

Einbau senkrechter Ablauf:

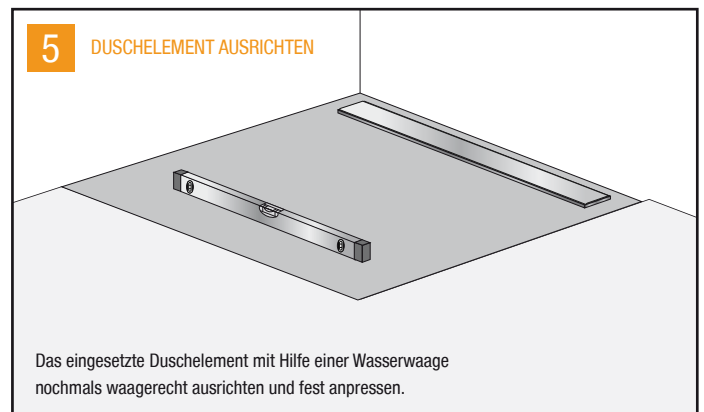
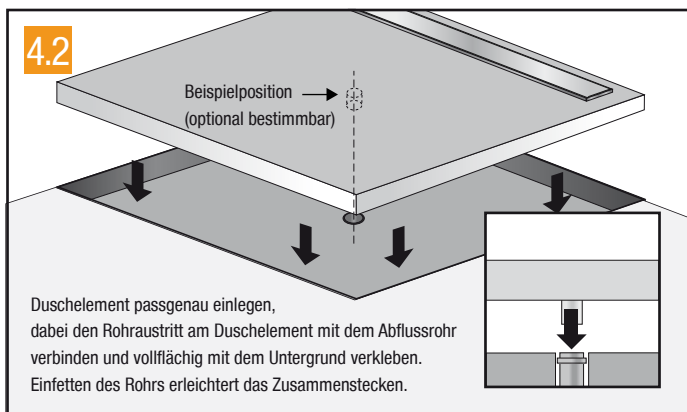

Einbau mit Dichtvlies Randüberstand:

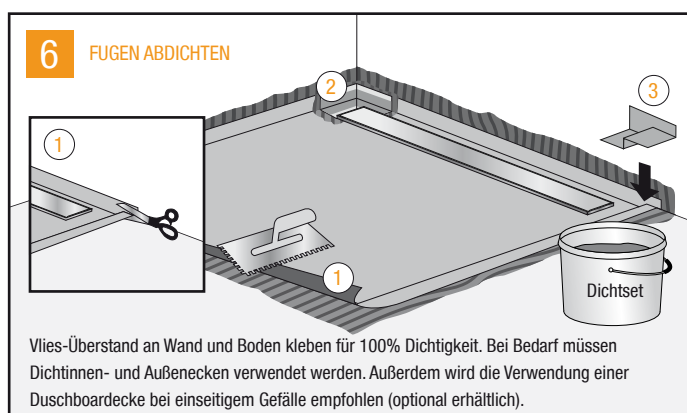

Alternativ: Einbau ohne Dichtvlies Randüberstand:

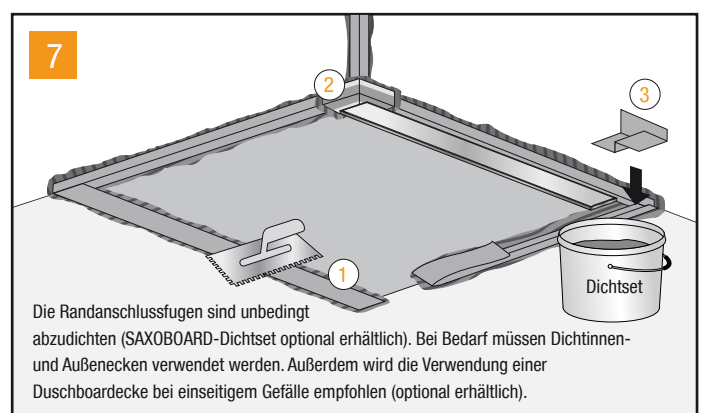

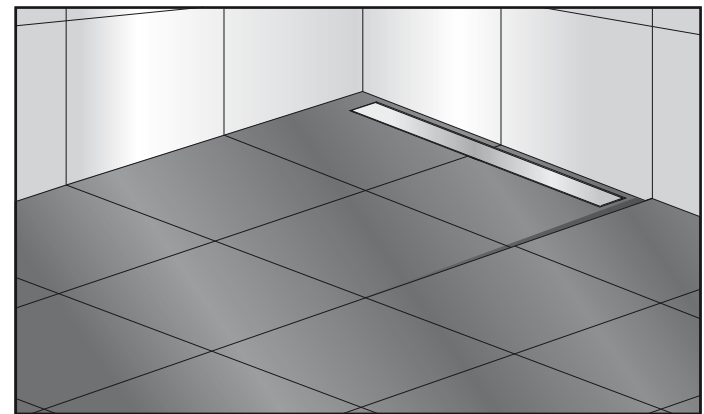
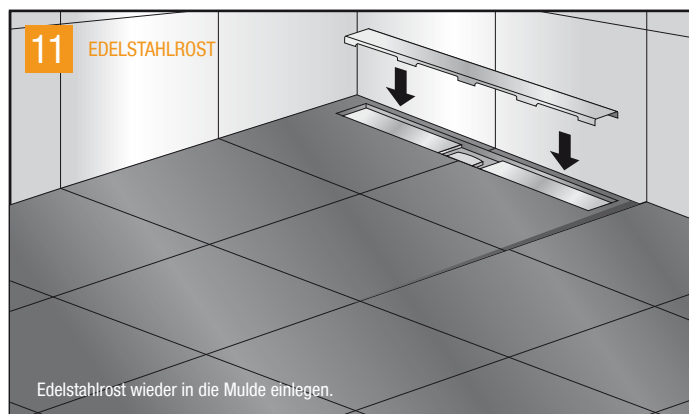
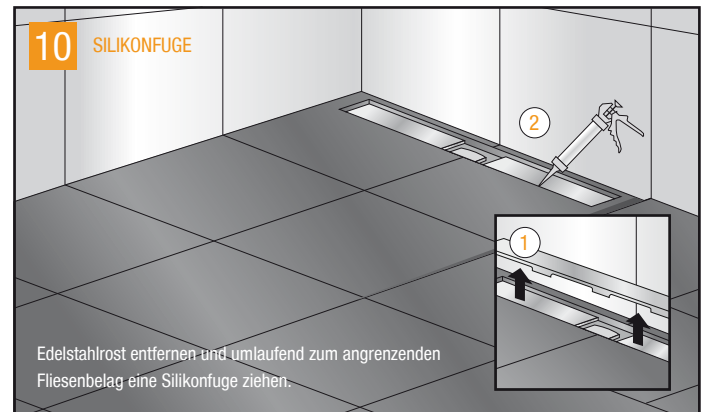
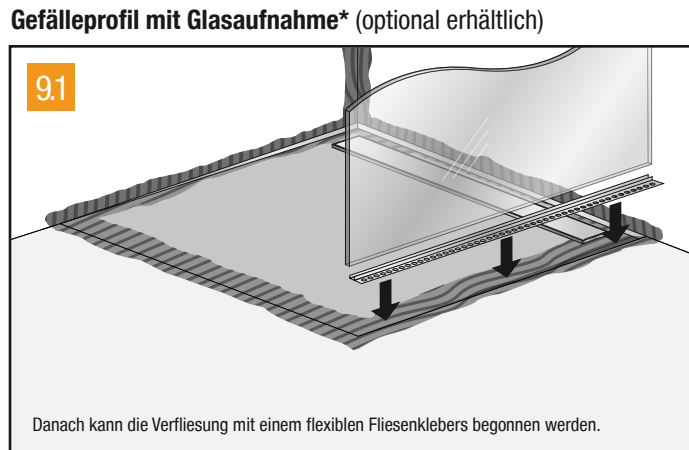
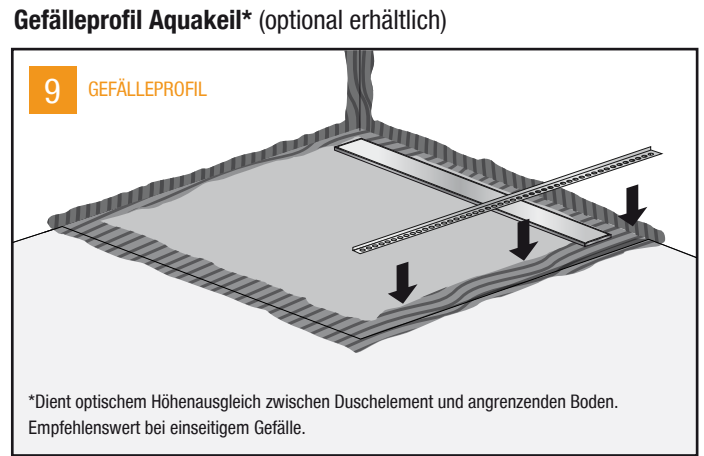
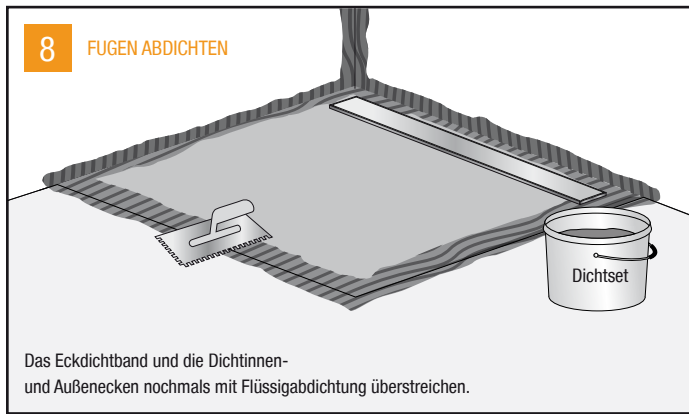

QR Code einscannen und noch mehr in unserem Montagevideo erfahren:



Disclaimer: Sämtliche Inhalte dieser Drucksache sind Eigentum der Firma SAXOBOARD® Wellness & Duschesysteme GmbH. Die Verwendung der Inhalte darf nur mit unserer ausdrücklichen schriftlichen Genehmigung erfolgen.